

Standard Circular (SC)

Standard Circular Inline Connector (SCIL)

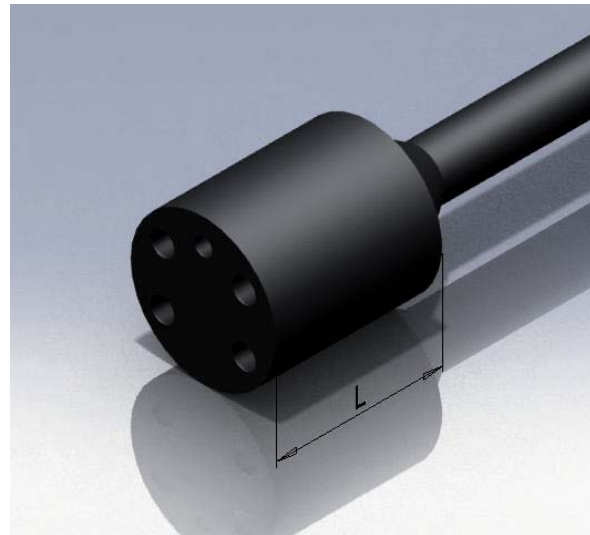

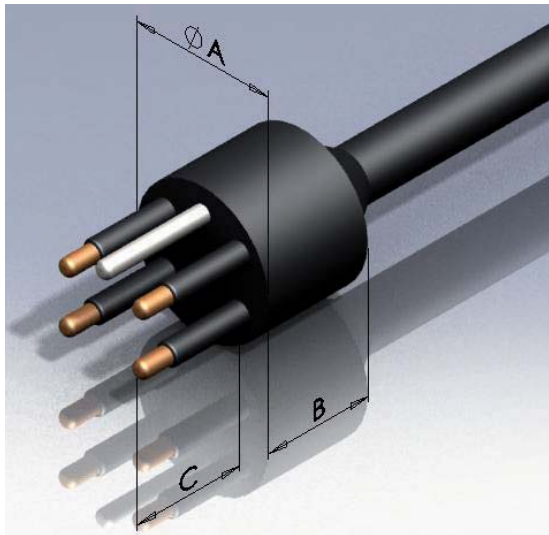

SCIL Data Table

Number of contacts	2	3	4	5	6	8	10	12	16
Dim. A [mm]	24.5	24.5	24.5	24.5	31.5	31.5	31.5	39.5	39.5
Dim. B [mm]	19	19	19	19	19	19	19	25.5	25.5
Dim. C [mm]	19	19	19	19	19	19	19	19	19
Dim. L [mm]	28.5	28.5	28.5	28.5	28.5	28.5	28.5	28.5	28.5
Locking Sleeve Type:	FLS-A, MLS-A	FLS-A, MLS-A	FLS-A, MLS-A	FLS-A, MLS-A	FLS-B, MLS-B	FLS-B, MLS-B	FLS-B, MLS-B	FLS-C, MLS-C	FLS-C, MLS-C
Cable OD [mm]	8	9.4	10	12	12.3	13.5	15	16	18
Cable current [A]	12	12	12	12	10	10	10	10	10
Ordering number for Male	SCIL2M	SCIL3M	SCIL4M	SCIL5M	SCIL6M	SCIL8M	SCIL10M	SCIL12M	SCIL16M
Ordering number for Female	SCIL2F	SCIL3F	SCIL4F	SCIL5F	SCIL6F	SCIL8F	SCIL10F	SCIL12F	SCIL16F
Note:									

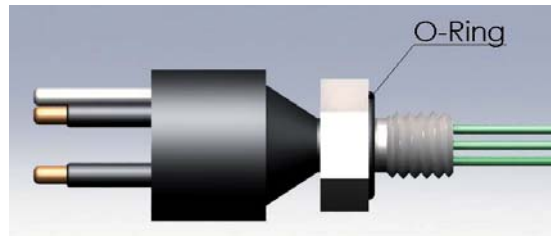
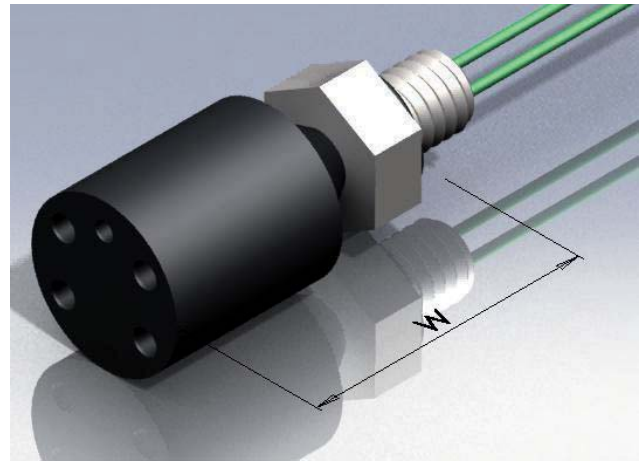
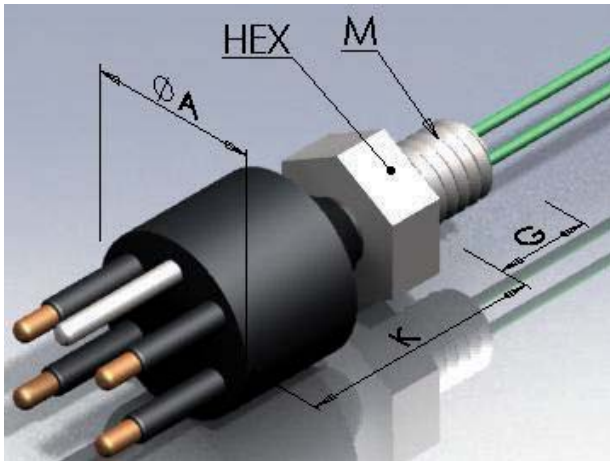
Standard Circular Bulk Head Connector (SCBH)



SCBH Data Table

Number of contacts	2	3	4	5	6	8	10	12	16
M[inch thread]	7/16-20 UNF	7/16-20 UNF	7/16-20 UNF	7/16-20 UNF	5/8-18 UNF	5/8-18 UNF	5/8-18 UNF	5/8-18 UNF	5/8-18 UNF
Dim. A [mm]	24.5	24.5	24.5	24.5	31.5	31.5	31.5	39.5	39.5
Dim. K [mm]	36	36	36	36	41	41	41	38.5	38.5
Dim. G [mm]	14	14	14	14	14 or 19	14 or 19	14 or 19	14 or 19	14 or 19
HEX [mm]	19	19	19	19	24	24	24	24	24
Dim. W [mm]	45	45	45	45	50	50	50	45	45
O-Ring [material: Nitrile]	2-014	2-014	2-014	2-014	2-017	2-017	2-017	2-017	2-017
Locking Sleeve Type:	FLS-A, MLS-A	FLS-A, MLS-A	FLS-A, MLS-A	FLS-A, MLS-A	FLS-B, MLS-B	FLS-B, MLS-B	FLS-B, MLS-B	FLS-C, MLS-C	FLS-C, MLS-C
Ordering number for Male	SCBH2M	SCBH3M	SCBH4M	SCBH5M	SCBH6M	SCBH8M	SCBH10M	SCBH12M	SCBH16M
Ordering number for Female	SCBH2F	SCBH3F	SCBH4F	SCBH5F	SCBH6F	SCBH8F	SCBH10F	SCBH12F	SCBH16F
Note:									

SC DATA

Contact Layout - SC

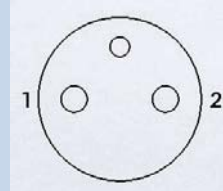
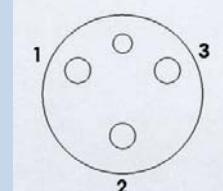
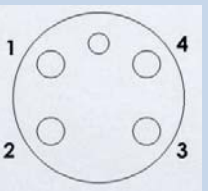
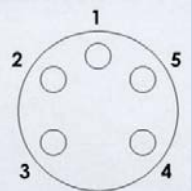
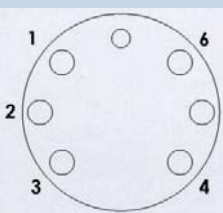
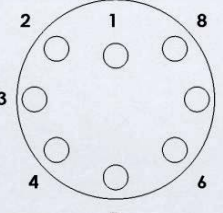
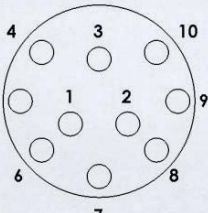
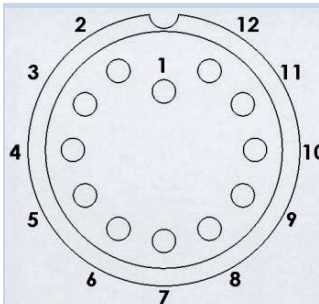
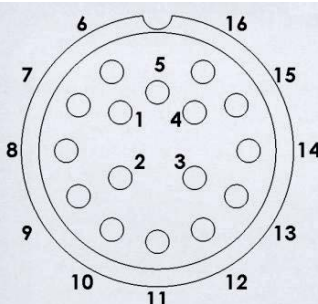
Number of contacts	2	3	4	5
Contact layout (Female) "A" size				
Number of contacts	6	8	10	
Contact layout (Female) "B" size				
Number of contacts	12	16		
Contact layout (Female) "C" size				

Specification - SC

Operational		Material	
Max Current	10-12A	Molding	Low Carbon Neoprene
Max Voltage	600V	Bulkhead	AL, Brass, 316S, TT2, PEEK
Insulation	>250megaohm	Contacts	Gold plated per MIL-G 45204 Type II, Grade D, Class 00
Contacts	<0.01 ohm	Pin	Phosphor Bronze
Matings	>750	Sockets	Beryllium Copper
Temperature	-5C - +65C	Location Pin	316 Stainless
Depth	>600 bar	In-line cable	60cm, AWG 18 (0.82mm ²) 16/30 stranding
		BH leads	30cm, AWG 18 Teflon, (0.97mm ²) 19/30 stranding